

## EPDM Rubber Angle Profile RCAP17X8W

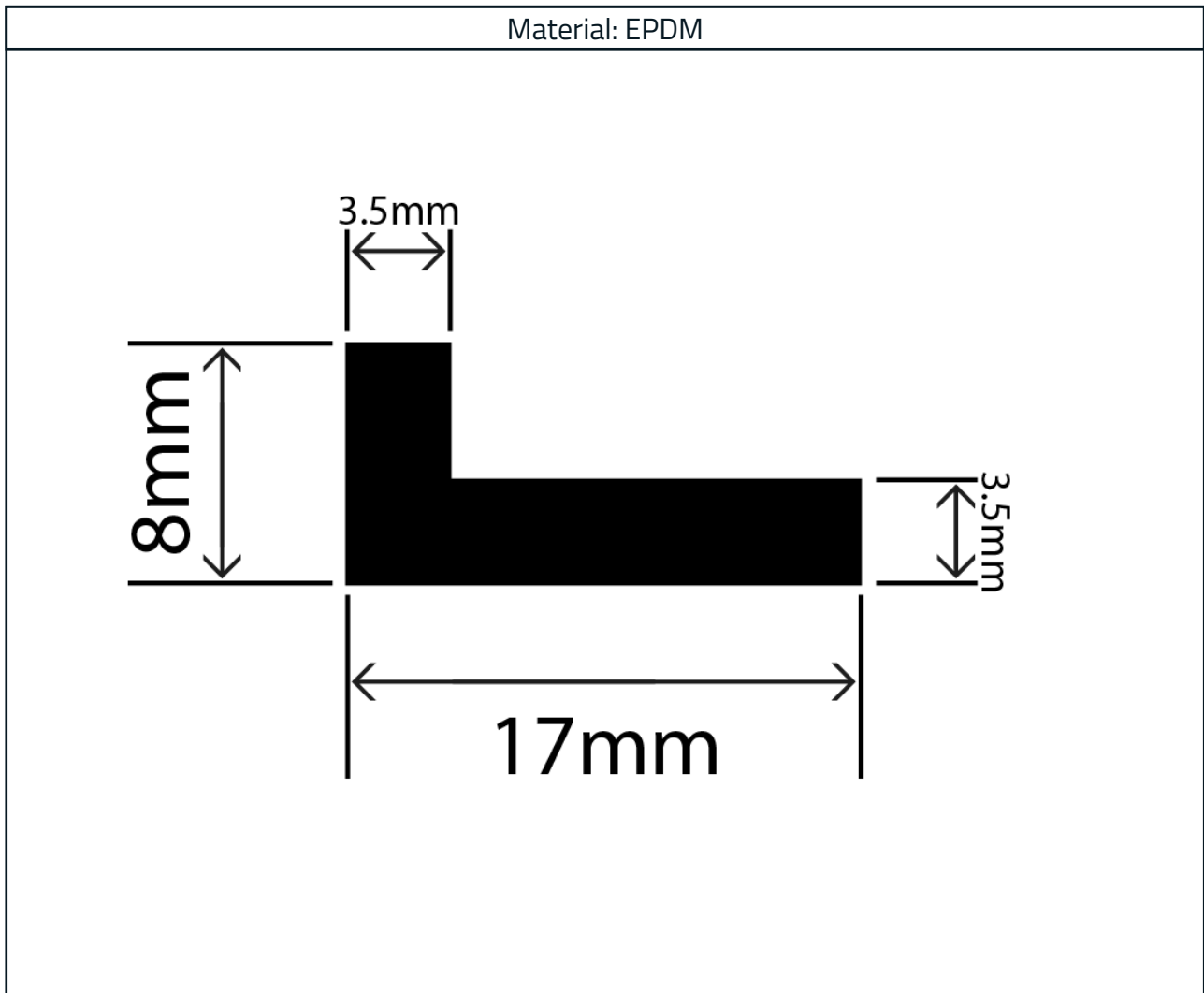

### Measurements:

Height	Width
8mm	17mm

The information contained on this product information sheet is to be used as guidance. The advice is given in good faith and does not constitute any guarantee or recommendation for suitability. The Rubber Company cannot be held liable for any damage caused by incorrect installation. We hereby reserve the right to change the technical information herewith without notification or prior agreement.



Manufacturers · Designers · Distributors

Experts in  
**Rubber**

## Technical Data

### Material Specification

Properties	Values
Polymer	EPDM
Hardness (Shore A)	70
Tensile Strength	7.0 MIN
Compression Set (20% Deflection at 70°C)	20.0 MAX
Elongation at Break	300.0 MIN



The information contained on this product information sheet is to be used as guidance. The advice is given in good faith and does not constitute any guarantee or recommendation for suitability. The Rubber Company cannot be held liable for any damage caused by incorrect installation. We hereby reserve the right to change the technical information herewith without notification or prior agreement.