

EPDM Lip Seal Profile 40mm x 40mm

Product Code: RCLS40X40W

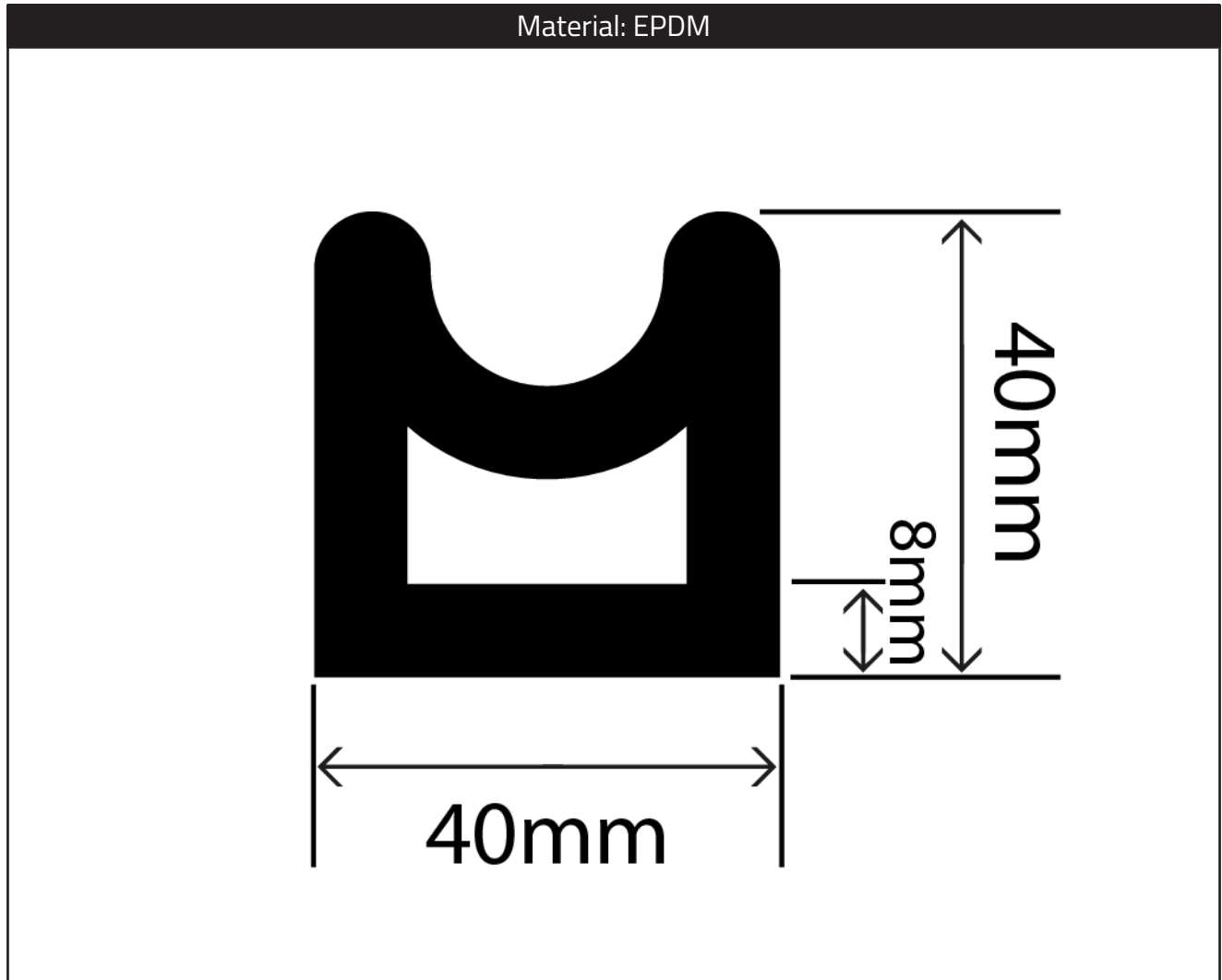

The information contained on this product information sheet is to be used as guidance. The advice is given in good faith and does not constitute any guarantee or recommendation for suitability. The Rubber Company cannot be held liable for any damage caused by incorrect installation. We hereby reserve the right to change the technical information herewith without notification or prior agreement.

Technical Data

Property	Test Method	Value
Compound	-	Ethylene Propylene Diene Monomer
Hardness (IRHD)	ISO 48	72° ± 5°
Hardness (Shore A)	ISO 868	70° ± 5°
Density	ISO 1183	1.26 g/cm ³ ± 2
Tensile Strength	ISO 37	7.0 MPa (min)
Elongation at Break	ISO 37	300 % (min)
Compression Set (24 h @ 70° C)	ISO 815	20 % (max)
Working Temperature Range	-	-40° C to +90° C

The information contained on this product information sheet is to be used as guidance. The advice is given in good faith and does not constitute any guarantee or recommendation for suitability. The Rubber Company cannot be held liable for any damage caused by incorrect installation. We hereby reserve the right to change the technical information herewith without notification or prior agreement.