

Industrial Easy-Lay Cable Protector - 270mm x 68mm

Product Code: RC-IELCP-270X68

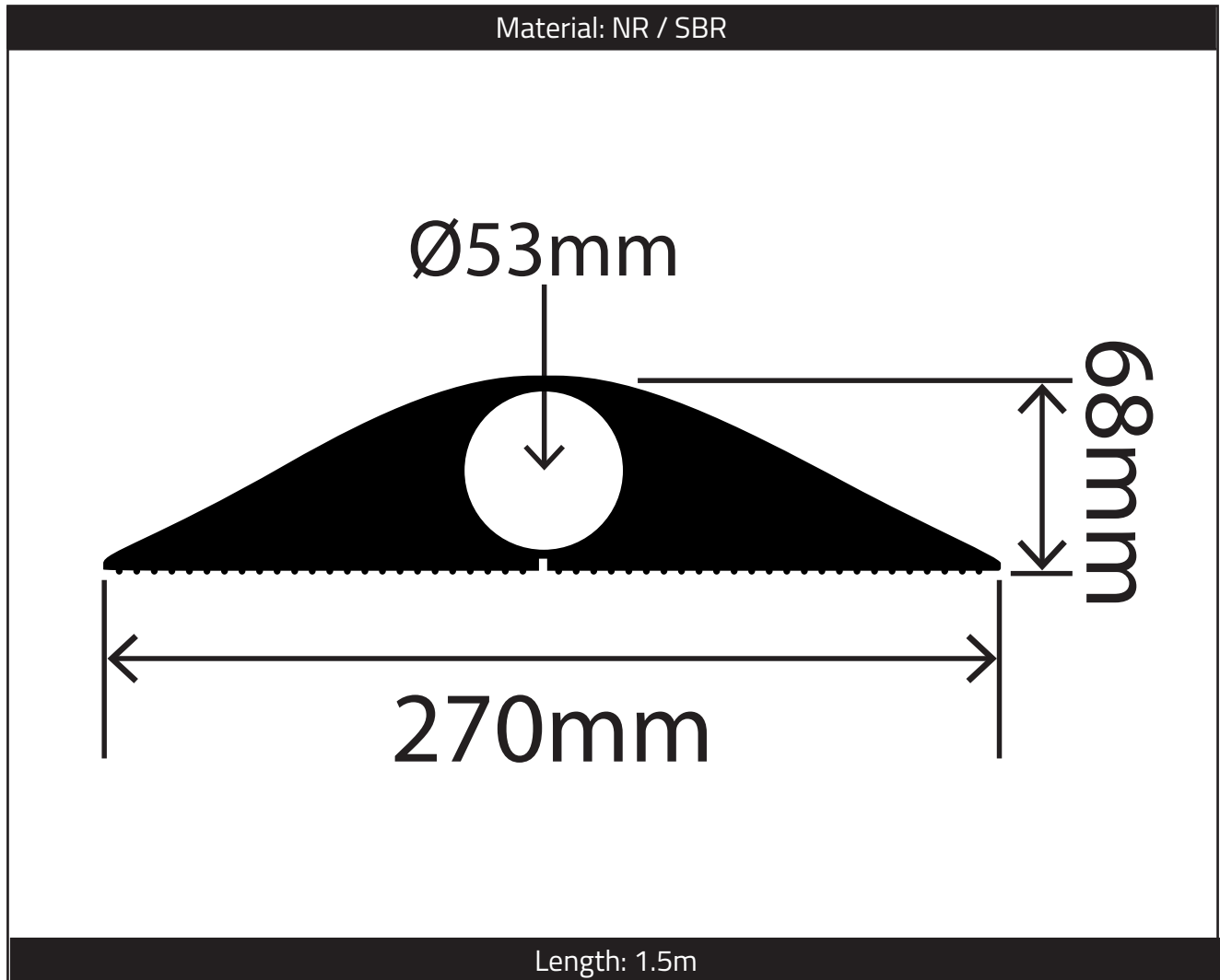

The information contained on this product information sheet is to be used as guidance. The advice is given in good faith and does not constitute any guarantee or recommendation for suitability. The Rubber Company cannot be held liable for any damage caused by incorrect installation. We hereby reserve the right to change the technical information herewith without notification or prior agreement.

Key Features

- Protects cables, pipes, and hoses in harsh, industrial environments
- Ideal for areas with frequent movement of vehicles
- Fire tested to BS 476 Part 7 Class 3
- Halogen-free in the event of fire
- Low smoke, non-toxic, and low emission
- Tested for non-conductivity to BS 903-C5, 500V
- Excellent UV resistance for outdoor use
- Available in black or grey

Material Specification

Property	Value
Material	Natural rubber / styrene-butadiene rubber blend
Hardness (Shore A)	75° ± 5°
Halogens	None
Fire Retardancy	BS 476 Part 7 Class 3 DIN Part 1 and Class B1
Conductivity	Non-conductive to BS 903 Part C5 At 500v - >2000MΩ At 1000v - 205MΩ
Adhesion	Can be fixed using a neoprene contact adhesive or an epoxy resin

The information contained on this product information sheet is to be used as guidance. The advice is given in good faith and does not constitute any guarantee or recommendation for suitability. The Rubber Company cannot be held liable for any damage caused by incorrect installation. We hereby reserve the right to change the technical information herewith without notification or prior agreement.